

Room/Wall Mount/Duct Mount Type Temperature/Humidity Transducer

■ Features

- Compact design
- Built-in temp./humidity sensor
- 7 Segment LED Display (THD-DD/THD-WD)
- Various output modes
DC4-20mA, 1-5VDC, RS485 (Modbus RTU)
- Wide range of temp./humidity measurement
-19.9 to 60.0°C / 0.0 to 99.9%RH
- Communication speed: 115200bps

⚠ Please read "Safety Considerations" in operation manual before using.

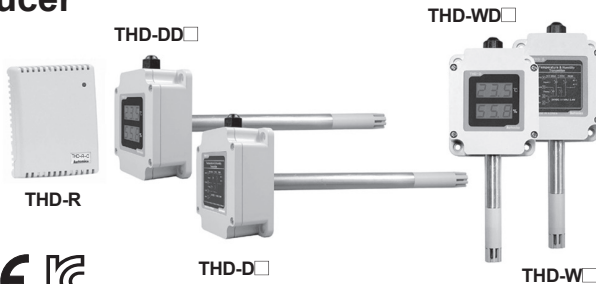

CE (only for THD-□-T model)

■ Ordering Information

THD - D D 1 - C

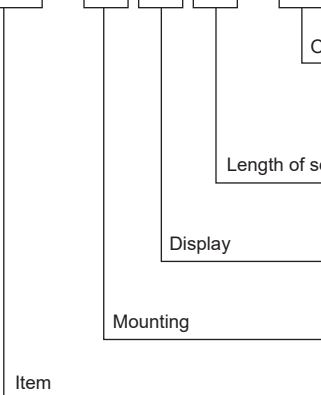

PT*	DPT100Ω resistance value (Temp.)
PT/C*	DPT100Ω resistance value (Temp.) / Current output (Humidity)
C	Current output (Temp./Humidity)
V	Voltage output (Temp./Humidity)
T	RS485 communication output (Temp./Humidity)
No mark*	Built-in
1	100mm
2	200mm
No mark	Non-Display type
D	Display type
R	Room type (for indoor)
D	Duct mounting type
W	Wall mounting type
THD	Temperature Humidity Double

■ Specifications

※It is only for THD-R.

Model	THD-R-PT	THD-R-PT/C	THD-R-C THD-R-V THD-R-T	THD-D□ - □ THD-W□ - □	THD-DD□ - □ THD-WD□ - □
Power supply	—	24VDC=			
Allowable voltage range	—	90 to 110% of rated voltage			
Power consumption	—	Max. 2.4W			
Sensor type	Temperature sensor	Temperature/Humidity sensor			
Display type	Non-indicating type			7-segment LED display	
Display digit	—			Each 3 digits for temp./humidity	
Character size	—			W6.2×H10.0mm	
Measurement range	Temp.	-19.9 to 60.0°C			
	Humidity	—	0.0 to 99.9%RH (THD-R is required to attend for using over 90%RH.)		
Accuracy*1	Temp.	Max. ±0.8°C	±1.0°C (at room temperature)		
	Humidity	—	±3%RH (30 to 70%RH, at room temp.), ±4%RH (10 to 90%RH)	Typ. ±2%RH (10 to 90%RH, at room temp.) ※Max. ±2.5%RH	
Output	Temp.	DPT100Ω resistance value (TCR: 3850ppm/°C)		DC4-20mA(allowable impedance: max. 600Ω), 1-5VDC=, RS485 communication (Modbus RTU)	
	Humidity	—	DC4-20mA (allowable impedance: max. 600Ω)		
Resolution	—	1/1000			
Sampling cycle	—	0.5 sec			
Insulation resistance	—	Over 100MΩ (at 500VDC megger)			
Dielectric strength	—	500VAC 50/60Hz for 1 minute			
Noise immunity	—	±0.3kV the square wave noise (pulse width: 1μs) by the noise simulator			

※1: •Room temperature is 23°C±5°C.

- It may cause degree of degradation when this unit is exposed to organic chemicals such as alcohol gas or sulfuric acid.
- It may cause degree of degradation for humidity when using this unit at high temperature/humidity environment for a long time.
- It may cause error of humidity value when this unit is exposed to high humidity environment (over 80%RH) for a long time.

(A) Photoelectric Sensors

(B) Fiber Optic Sensors

(C) Door/Area Sensors

(D) Proximity Sensors

(E) Pressure Sensors

(F) Rotary Encoders

(G) Connectors/ Connector Cables/ Sensor Distribution Boxes/Sockets

(H) Temperature Controllers

(I) SSRs / Power Controllers

(J) Counters

(K) Timers

(L) Panel Meters

(M) Tacho / Speed / Pulse Meters

(N) Display Units

(O) Sensor Controllers

(P) Switching Mode Power Supplies

(Q) Stepper Motors & Drivers & Controllers

(R) Graphic/ Logic Panels

(S) Field Network Devices

(T) Software

THD Series

Specifications

Model		THD-R-PT	THD-R-PT/C	THD-R-C THD-R-V THD-R-T	THD-D□-□ THD-W□-□	THD-DD□-□ THD-WD□-□
Vibration	Mechanical	—	0.75mm amplitude at frequency of 10 to 55Hz (for 1 min) in each X, Y, Z direction for 1 hour			
	Malfunction	—	0.5mm amplitude at frequency of 10 to 55Hz (for 1 min) in each X, Y, Z direction for 10 min			
Shock	Mechanical	—	300m/s ² (approx. 30G) in each X, Y, Z direction for 3 times			
	Malfunction	—	100m/s ² (approx. 10G) in each X, Y, Z direction for 3 times			
Protection structure		IP10			IP65 (except sensing part)	
Ambient temperature		-20 to 60°C, storage: -20 to 60°C				
Cable		—			Ø4mm, 4-wire, Length: 2m (AWG22, Core diameter: 0.08mm, number of cores: 60, insulation out diameter: Ø1.25mm)	
Approval		CE,  (only for THD-□-T model)				
Weight ^{※2}		Approx. 98g (approx. 55g)			Approx. 415g (approx. 160g)	

※2: The weight includes packaging. The weight in parenthesis is for unit only.

※Environment resistance is rated at no freezing or condensation.

Dimensions

(unit: mm)

● THD-R

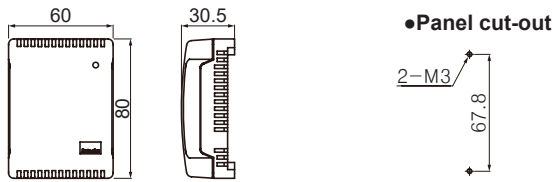

● THD-W

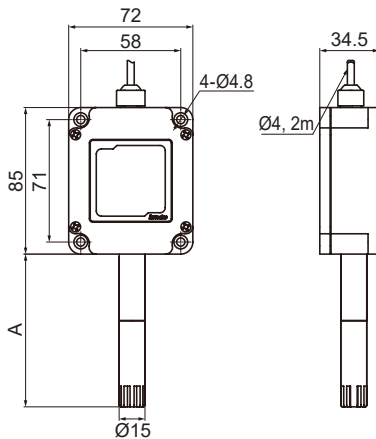

Model	Length of sensor pole (A)
THD-□1-□	100mm
THD-□2-□	200mm

● THD-D

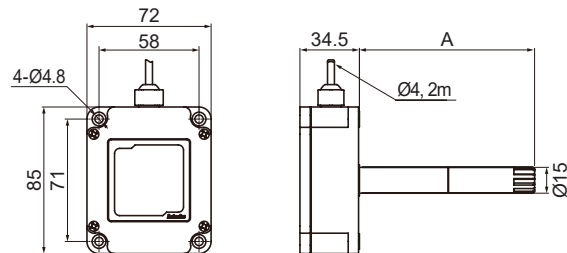

● Bracket

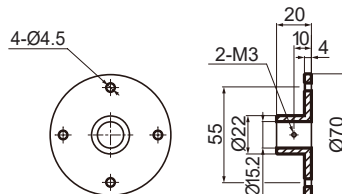

● Panel cut-out

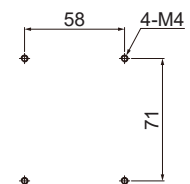

Temperature/Humidity Transducer

Connections

THD-R

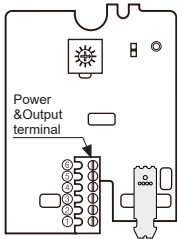

※Check the terminal connection diagram and be sure that when connecting the power.

THD-R-PT

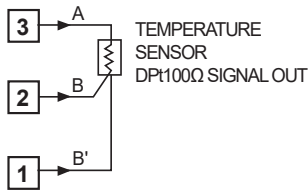

THD-R-C, V, T

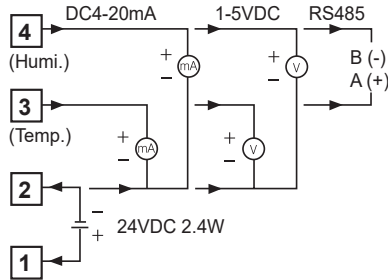

THD-R-PT/C

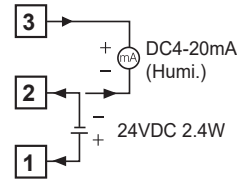
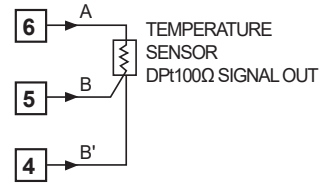

THD-D / THD-W

THD-D-C / THD-W-C

DC4-20mA (Humi.)

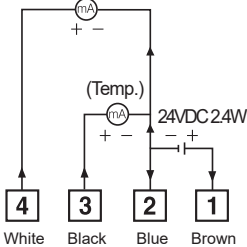
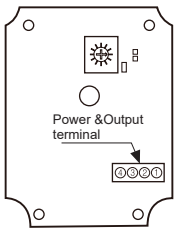

THD-D-V / THD-W-V

1-5VDC (Humi.)

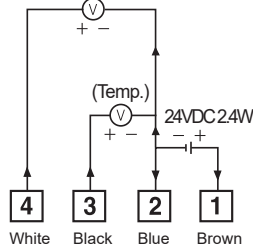

THD-D-T / THD-W-T

RS485 (Temp. & Humi.)

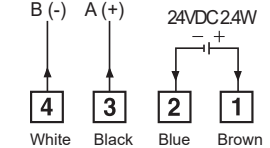

Case Detachment

THD-R

Unfasten the bolt on the bottom of the product, separate the case from it.

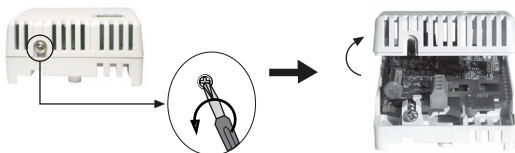

THD-D / THD-W

Unfasten 4 bolts on the top of the product, separate the case cover from it.

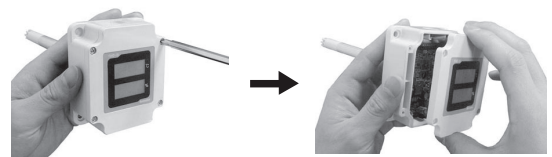

(A)	Photoelectric Sensors
(B)	Fiber Optic Sensors
(C)	Door/Area Sensors
(D)	Proximity Sensors
(E)	Pressure Sensors
(F)	Rotary Encoders
(G)	Connectors / Connector Cables / Sensor Distribution Boxes/Sockets
(H)	Temperature Controllers
(I)	SSRs / Power Controllers
(J)	Counters
(K)	Timers
(L)	Panel Meters
(M)	Tacho / Speed / Pulse Meters
(N)	Display Units
(O)	Sensor Controllers
(P)	Switching Mode Power Supplies
(Q)	Stepper Motors & Drivers & Controllers
(R)	Graphic/ Logic Panels
(S)	Field Network Devices
(T)	Software

THD Series

■ Functions

◎ Voltage output

It transmits current temperature/humidity to other devices (PC, recorder, etc.) and outputs 1-5VDC. It outputs 1VDC at -19.9°C of temperature and 0%RH of humidity, 5VDC at 60°C of temperature and 99.9%RH of humidity. The temperature and humidity output are separated and the resolution is divisible by 1,000.

◎ Current output

It transmits current temperature/humidity to other devices (PC, recorder, etc.) and outputs DC4-20mA. It outputs DC4mA at -19.9°C of temperature and 0%RH of humidity, DC20mA at 60°C of temperature and 99.9%RH of humidity. The temperature and humidity output are separated and the resolution is divisible by 1,000.

◎ DPt 100Ω resistance value output

It transmits current temperature to other devices (recorder, thermometer, etc.). It outputs 100Ω at 0°C and 119.40Ω at 50°C. (Temperature coefficient(TCR)=3850 ppm/°C)

■ Comprehensive Device Management Program [DAQMaster]

- DAQMaster is comprehensive device management program for convenient management of multiple device data monitoring.
- Visit our website (www.autonics.com) to download user manual and comprehensive device management program.

< Computer specification for using software >

Item	Minimum requirements
System	IBM PC compatible computer with Intel Pentium III or above
Operations	Microsoft Windows 98/NT/XP/Vista/7/8/10
Memory	256MB+
Hard disk	1GB+ of available hard disk space
VGA	Resolution: 1024×768 or higher
Others	RS-232 serial port (9-pin), USB port

< DAQMaster screen >

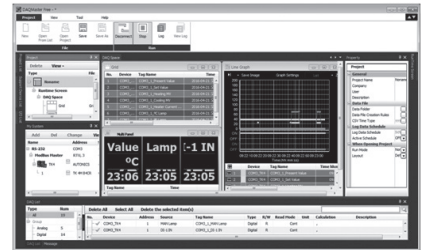

■ Sold Separately

◎ Communication converter

- **SCM-WF48**
(Wi-Fi to RS485-USB wireless communication converter)
CE



- **SCM-US48I**
(USB to RS485 converter)
CE



- **SCM-38I**
(RS232C to RS485 converter)
CE



◎ Display units (DS/DA-T Series)

- **DS/DA-T Series**
- (RS485 communication input type display unit)



DS16-□T



DS22/DA22-□T



DS40/DA40-□T



DS60/DA60-□T

※Connect RS485 communication input type display unit (DS/DA-T Series) and RS485 communication output model of THD Series, the display unit displays present value of the device without PC/PLC.

Temperature/Humidity Transducer

■ RS485 Communication Output

It is output transmit current temperature and humidity to other devices by communication.

◎ Interface

Comm. protocol	Modbus RTU
Connection type	RS485
Application standard	Compliance with EIA RS485
Max. connection	31units (address: 01 to 31)
Synchronous method	Asynchronous
Comm. method	Two-wire half duplex
Comm. distance	Max. 800m
Comm. speed	1200 to 115200bps (selectable)
Start bit	1-bit (fixed)
Data bit	8-bit (fixed)
Parity bit	None (fixed)
Stop bit	1-bit (fixed)

※It is not possible to change parameter related to communication of THD under the communication with high order system.

(At communication status, THD and upper system are available to change the address.)

※Match the parameter of THD communication to be same as the high order system.

※It is not allowed to set overlapping communication address at the same communication line.

◎ Application of system organization

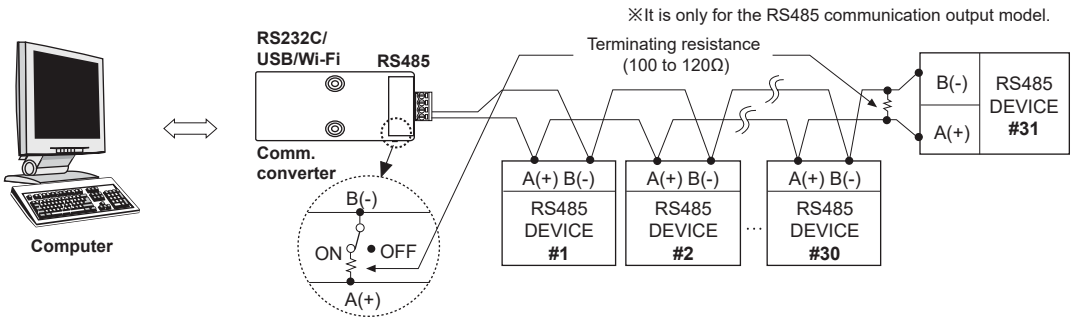

※It is recommended to use Autonics communication converter; SCM-WF48 (Wi-Fi to RS485-USB wireless communication converter, sold separately), SCM-US48I (USB to RS485 converter, sold separately), SCM-38I (RS232C to RS485 converter, sold separately).

Please use twisted pair wire, which is suitable for RS485 communication, for SCM-WF48, SCM-US48I and SCM-38I.

◎ Ordering of communication control

- The communication method is Modbus RTU.
- After 2.0 sec being supplied the power into master system, it is able to start communication.
- The initial communication is started by master system. When a command comes out from the master system, THD will respond.

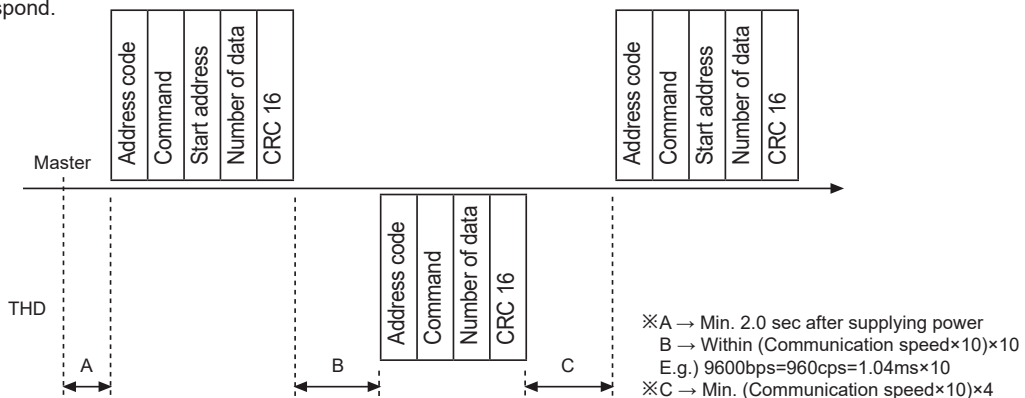

- (A) Photoelectric Sensors
- (B) Fiber Optic Sensors
- (C) Door/Area Sensors
- (D) Proximity Sensors
- (E) Pressure Sensors
- (F) Rotary Encoders
- (G) Connectors/ Connector Cables/ Sensor Distribution Boxes/Sockets
- (H) Temperature Controllers
- (I) SSRs / Power Controllers
- (J) Counters
- (K) Timers
- (L) Panel Meters
- (M) Tacho / Speed / Pulse Meters
- (N) Display Units
- (O) Sensor Controllers
- (P) Switching Mode Power Supplies
- (Q) Stepper Motors & Drivers & Controllers
- (R) Graphic/ Logic Panels
- (S) Field Network Devices
- (T) Software

THD Series

● Communication command and block

The format of query and response.

Query

Address code	Command	Start address	Number of data	CRC16
← Calculation range of CRC16 →				

- ① Address code: This address code is for identifying THD by master system and able to set within range of 01 to 31.
- ② Command: Read command for input register
- ③ Start address: The start address of input register to read (Start address). It is available to select 0000 and 0001 for start address. 16bit data in the address 0000 indicates temperature value, 16bit data in the address 0001 indicates humidity value. (Refer to Modbus Mapping table.)
- ④ Number of data: The number of 16bit data from start address (No. of Points). When start address is 0000, it is available to read 2 of 16 bit data, or when start address is 0001, it is available to read 1 of 16 bit data.
- ⑤ CRC16: Checksum for checking the whole frame and it is used for more reliable transmit/receive to check the error between transmitter and receiver.

Response

Address code	Command	Number of data	Temperature data	Humidity data	CRC16
← Calculation range of CRC16 →					

- ① Address code: This address code is for identifying THD by master system and able to set within range of 01 to 31.
- ② Command: A response for read command of input register
- ③ Number of data: The number of 8 bit data to send from start address (No. of bytes). When start address is 0000, it is available to read 4 of 8 bit data, or when start address is 0001, it is available to read 2 of 8 bit data.
- ④ Temperature data: This is the value of 16bit. To get a current temperature value, divide read value by 100.
E.g.)When read data is 0×09B0, decimal value is 2480, the current value is 2480/100=24.80°C.
- ⑤ Humidity data: This is the value of 16bit. To get a current humidity value, divide read value by 100.
E.g.)When read data is 0×0B68, decimal value is 2920, the current value is 2920/100=29.20%RH.
- ⑥ CRC16: Checksum for checking the whole frame.

● Application for communication command

(Query): Address code (01), Start address (0000), The number of 16 bit data to read (2) CRC16 (0x71CB)

01	04	00	00	00	02	71	CB
Address code	Command	Start address		Amount of data		CRC16	
		High	Low	High	Low	High	Low

(Response): Address code (01), The number of 8 Bit data to read (4), Temperature (0x09B0), Humidity (0x0B68) CRC (0x94DE)

01	04	04	09	B0	0B	68	94	DE
Address code	Response command	Amount of data	Temperature data		Humidity data		CRC16	
			High	Low	High	Low	High	Low

● Error processing (slave → master)

1. Not supported command

01	8X	01	XX	XX
Address code	Response command	Exception code	CRC16	

※Set a received highest bit and send it to response command and exception code 01.

2. The start address of queried data is inconsistent with the transmittable address or the requested number of data is bigger than the transmittable address.

01	84	02	C2	C1
Address code	Response command	Exception code	CRC16	

※Set a received highest bit and send it to response command and exception code 02.

Temperature/Humidity Transducer

◎ Setting communication speed

- 1) Turn off the power of the unit.
 - 2) Set SW1 to 0 and apply the power.
 - 3) Operation indicator LED is flashing.
 - 4) Set a communication speed after choose SW1 within the range 1 to 8 and hold it for 3 sec.
 - 5) After setting a communication speed, the LED will be ON. At the moment turn OFF the power.
- ※Factory default communication speed is 9600bps.

<Setting table for communication speed (bps)>

SW1	Communication speed (bps)
1	1200
2	2400
3	4800
4	9600
5	19200
6	38400
7	57600
8	115200

◎ Change the communication address

- 1) Set Upper address setting terminal and SW1 at new address, apply the power.
 - 2) The communication address is changed automatically.
- ※Factory default communication address is 01. (SW1: 1, Upper address setting terminal: Open)
 ※Setting table of communication address

Upper address setting terminal	SW1	Add no.	Upper address setting terminal	SW1	Add no.
OPEN	1	01	SHORT	0	16
OPEN	2	02	SHORT	1	17
OPEN	3	03	SHORT	2	18
OPEN	4	04	SHORT	3	19
OPEN	5	05	SHORT	4	20
OPEN	6	06	SHORT	5	21
OPEN	7	07	SHORT	6	22
OPEN	8	08	SHORT	7	23
OPEN	9	09	SHORT	8	24
OPEN	A	10	SHORT	9	25
OPEN	B	11	SHORT	A	26
OPEN	C	12	SHORT	B	27
OPEN	D	13	SHORT	C	28
OPEN	E	14	SHORT	D	29
OPEN	F	15	SHORT	E	30
—	—	—	SHORT	F	31

<Inner PCB of THD-R>

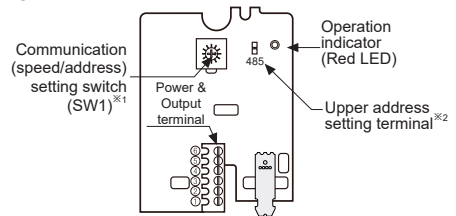

<Inner PCB of THD-D/THD-W>

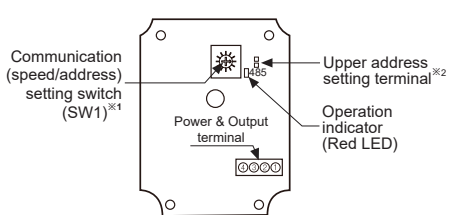

- ※1. Only when communication setting, remove the case cover and adjust the communication setting switch to set address and communication speed.
 ※2. Short terminal as upper address setting terminal, the lower address setting is available.

◎ Modbus mapping table

Address	Item	Remark
300001 (0000)	Temperature value	Temperature value × 0.01
300002 (0001)	Humidity value	Humidity value × 0.01

※Visit our website (www.autonics.com) to download monitoring program for RS485 communication output.

■ Cautions during Use

- Follow instructions in 'Cautions during Use'. Otherwise, it may cause unexpected accidents.
- Keep away from high voltage lines or power lines to prevent inductive noise.
 In case installing power line and input signal line closely, use line filter or varistor at power line and shielded wire at input signal line.
 Do not use near the equipment which generates strong magnetic force or high frequency noise.
- Install a power switch or circuit breaker in the easily accessible place for supplying or disconnecting the power.
- 24VDC power supply should be insulated and limited voltage/current or Class 2, SELV power supply device.
- Do not overlapping communication line and power line.
 Use twisted pair wire for communication line and connect ferrite bead at each end of line to reduce the effect of external noise.
- Do not touch TDH-W/D sensor part at the bottom of the sensor pole by hands.
 It may cause malfunction.
- THD-R must be installed on the wall.
 It may cause malfunction.
- Make a required space around the unit for radiation of heat.
 For accurate temperature measurement, warm up the unit over 20 min after turning on the power.
- Make sure that power supply voltage reaches to the rated voltage within 2 sec after supplying power.
- Do not wire to terminals which are not used.
- This unit may be used in the following environments.
 - ①Indoors
 (in the environment condition rated in 'Specifications')
 - ②Altitude max. 2,000m
 - ③Pollution degree 2
 - ④Installation category II

(A)	Photoelectric Sensors
(B)	Fiber Optic Sensors
(C)	Door/Area Sensors
(D)	Proximity Sensors
(E)	Pressure Sensors
(F)	Rotary Encoders
(G)	Connectors/ Connector Cables/ Sensor Distribution Boxes/Sockets
(H)	Temperature Controllers
(I)	SSRs / Power Controllers
(J)	Counters
(K)	Timers
(L)	Panel Meters
(M)	Tacho / Speed / Pulse Meters
(N)	Display Units
(O)	Sensor Controllers
(P)	Switching Mode Power Supplies
(Q)	Stepper Motors & Drivers & Controllers
(R)	Graphic/ Logic Panels
(S)	Field Network Devices
(T)	Software